



SPW-Series Stretch Pallet Wrapper
Model: SPW-983HP, SPW-983LP

Distributed By:

Version 1.0
Last Updated: 10/10/19

IMPORTANT - PLEASE READ THIS CAREFULLY

The development of a good safety program, that is rigidly enforced, is absolutely imperative when involved in the operation of industrial equipment. Our machinery is well designed and includes extremely important safety features. The part you the user play through proper installation and maintenance procedures is of far greater significance than our designs. Only properly trained individuals following rigidly enforced safety rules, as recommended by A.N.S.I. and O.S.H.A., should be allowed to operate these machines.

SPW-983 Pallet Wrapper Manual

TABLE OF CONTENTS

Preface

Warranty Notice	5
Warranty	6-7
Warranty Exceptions	8
Warnings	9-10
General Safety Regulations	11

Pallet Wrapper Section

Description	12
Specifications	13
Technical Data	14
Unpacking	15-16
Installation and basic set up	17-24
Installation of Optional Loading Ramp	23
Plugging Machine In	24
Installation of film roll	25
Stretch Film Threading Diagram	26
Front control panel	27
Turning on machine	28-29
7" Color Touch Screen nomenclature	30-31
Manual Mode Screen nomenclature	31-32
Sequence of operation	33
Setting machine parameters	33-46
Set Top and Bottom wrap counts	34-35
Set Carriage Speed and Turntable Speed	36-37
Set Photo Eye and Photo Eye Delay	37
Turn Photo Eye OFF	38
Top Sheet On/ Off	39
"Optional" Top Platen	40
"Optional" Insta-Cut / Auto Tearing feature	41-43
Set Tension Control	43-44
Machine Pause	44

Getting Started with first pallet load	47-49
---	--------------

SPW-983 Pallet Wrapper Manual

Troubleshooting	50-56
Machine does not start	50-52
Machine in Emergency Stop Mode	53
Turntable will not turn	54
Film Carriage will not rise	55-56
Maintenance	57-60
General Maintenance Requirements	57
Checking turntable chain tension	57-58
Lubrication of Chain	59
Replacing the turntable support rollers	59
Adjustment of photo eye	60
Exploded view drawings with parts listings	61-72
Spare Parts List	73
Electrical Schematic	74
Notes Page	75

IMPORTANT WARRANTY NOTICES

OPERATING AND MAINTENANCE MANUAL

The operating and maintenance manual has been carefully prepared to provide the user with all the information needed to properly install, operate, and maintain your equipment

Please read this manual carefully and refer to it for information on the care and use of your equipment. It is recommended that additional copies be ordered for use by production, maintenance, and supervisory personnel. Although the design of this equipment incorporates safeguards to protect personnel, care should be used in operating, adjusting, and servicing.

Attention is directed to the warranty which accompanies all your equipment. The terms and conditions of this warranty apply only to unmodified units. Any unauthorized modifications to the equipment automatically voids this warranty.

Sealer Sales

WARRANTY

Sealer Sales, Inc. warrants each new product manufactured to be free from defects in material and workmanship for a period of **3 years from date of shipment** by Sealer Sales.

Not covered by this warranty is normal wear of components such as, but not limited to; belts, chains, fuses, bulbs, rollers etc. or misuse or abuse of the machine or any components thereof. As well, parts returned without the prescribed paperwork will not be covered by this warranty. Labor to remove or repair any component is also not covered by this warranty. Damage in transport is the responsibility of the carrier and is not covered under our warranty.

This warranty is not transferable with any subsequent resale.

Defective parts under warranty must be returned to Sealer Sales freight prepaid. Sealer Sales's sole obligation and purchaser's sole remedy in the event of a warranty dispute shall be, at Sealer Sales's option, to repair or replace the part in question. Labor incurred in removing or installing the defective part is not covered by this warranty. Prior to returning any parts for any reason, contact Sealer Sales for a Return Authorization Number. This number must accompany all returns.

This warranty shall not apply if equipment has been tampered with, misused, improperly installed, altered, or has received damage due to abuse, carelessness, accident or failure to follow recommended regular maintenance procedures or has been serviced by someone other than a duly authorized factory representative without the express written consent of Sealer Sales, Inc.

SPW-983 Pallet Wrapper Manual

This warranty is in lieu of all other warranties, expressed or implied, including but not limited to warranties of merchantability and fitness for a particular purpose, non-infringement or any other matter.

Sealer Sales shall have no liability to any person for direct, indirect, incidental or consequential damages or delay resulting from any defect negligence, or tort and customer hereby waives for itself any and all claims for punitive damages and all claims of negligence of strict liability or both. In no event shall our liability exceed the purchase price of the product which was actually paid.

Sealer Sales reserves the right to make changes, additions, or improvements to our products with no obligation to make such changes in any previously shipped product covered by this warranty.

Sealer Sales shall not be held liable for any damages arising out of or in connection with the operation of the equipment should customer or its agent fail to maintain equipment in safe operating condition. This warranty shall become unenforceable if and to the extent the customer or its agents remove, disconnect, or otherwise render useless any safety device and or parts designed or affixed by us or fails to maintain and service equipment in a manner as advised.

Sealer Sales provides a 3 year warranty on parts, excluding shipping or freight costs for replacement parts. All warranty parts are shipped F.O.B. Rancho Cucamonga, California.

WARRANTY EXCEPTIONS

The following parts are an exception to the general warranty list on page 9. Each part listed below shall carry a 30-day warranty unless designated otherwise.

SPW-983

1. Fuses

WARNINGS

Every effort has been taken to ensure your safety while operating this machine; however, there still remain certain risks. Do not allow this machine to be operated before informing all personnel of the following warnings.

WARNING.....

Do not tamper with the electrical wiring. Only use a licensed electrician for maintenance. Always disconnect the electrical power before attempting any maintenance to all electrical and/or moving parts.

WARNING.....

In order to prevent injury to personnel and/or machinery DO NOT INCREASE SETTINGS OR RATINGS ON EITHER ELECTRICAL OR MECHANICAL OVERLOAD SAFETY DEVICES.

WARNING.....

KEEP HANDS AWAY FROM MOVING CONVEYORS AND ASSEMBLIES. Conveyor belts that have become worn or frayed are capable of being hazardous. They should be replaced promptly.

WARNING.....

NEVER OPERATE THIS OR ANY MOVING EQUIPMENT WITHOUT ALL COVERS AND GUARDS IN PLACE. The internal mechanism of most packaging machinery contains numerous shear, pinch, and inrunning nip points, many of which are capable of causing severe injury and/or permanent disfigurement.

SPW-983 Pallet Wrapper Manual

WARNING.....

To minimize the potential for personnel injury, always be sure that machine operators and others working on the machinery are properly trained in the correct usage of the equipment and properly instructed regarding the safety procedures for operation.

WARNING.....

ANY MODIFICATIONS TO EITHER THE ELECTRICAL CIRCUITRY OR THE MECHANICAL ASSEMBLIES OF THE MACHINERY WILL VOID ANY WARRANTIES ASSOCIATED WITH THIS EQUIPMENT. Such modifications may introduce hazards that would not otherwise be associated with this machinery. Sealer Sales will not be responsible for any consequences resulting from such unauthorized modifications.

WARNING.....

It is important that the machine operator turn off the Main Power Switch when he/she has finished operating the unit.

General Safety Regulations

Before using the machine or carrying out maintenance operations read the following instructions very carefully:

Before

1. Read the instructions about how to set up the machine
2. Check all the safety guards on the machine and immediately replace any worn or broken parts with original spares.
3. Make sure that no tools or other objects have been left lying on the machine and that the machine itself is perfectly clean.
4. Read the maintenance and spare parts very carefully.
5. Read all the labels and plates applied to the machine.

During

1. Do not wear clothing that could get tangled up in the moving parts of the machine.
2. Do not put the hands or any kind of object inside the field of operation of the machine
3. Do not load the machine with boxes heavier than those recommended by the manufacturer.

After

1. Always stop the electric motor by pressing the red button on the switch
 2. Switch off the electric power.
-
-

SPW-983 Pallet Wrapper Manual

Description

The model SPW-983 is a versatile, reliable and economical pallet stretch wrapping machine designed to accommodate a large variety of pallet sizes. Using modern technology the model SPW-983 will apply stretch film to a pallet load. This inexpensive system offers a high degree of protection for any pallet load.

Operation

The operation of the model SPW-983 pallet wrapper comprises 4 easy steps

1. Operator places pallet load on revolving turntable by means of forklift or pallet jack (if optional ramp is used)
 2. Operator attaches stretch film to turntable base
 3. Press "start" cycle for automatic operation
 4. Cut film from pallet load at completion of work cycle.
-
-

SPW-983 Pallet Wrapper Manual

Specifications**Roll Dimensions**

The machine is capable of using different types of stretch film with the following dimensions:

- A: Internal diameter of roll 3" (76.2mm)
- B: External diameter of roll 12" (300mm)
- C: Height of roll: 20"
- D: Thickness of film: STD 60, 70 or 80gauge
*Other film thickness may be used
- E: Weight of roll: 40lbs max

In order to obtain the best results while using your machine we recommend using a good quality stretch film.

Pallet Dimensions

The model SPW-983 can generally wrap pallets with the overall dimensions listed below

- Maximum Length: 48" (1,200mm)
- Maximum Width: 48" (1,200mm)
- Maximum Height: 85" (2,150mm)

Pallet Weight

Maximum recommended pallet weight load is 4,000lbs (1,800kg)

SPW-983 Pallet Wrapper Manual

Technical Data

Machine Weight	1,450lbs (660kg)
Shipping Weight-Approximate	1,625lbs (738kg)
Crated Dimensions	124" L x 69" W x 35" H (3,150mm) x (1,750mm) x (890mm)
Power Requirements	110volt/15amp
Recommended Operating Temperatures	Min 40 f / Max 104 f +5 / +40 c
Turntable Rotation Speed	12RPM

UNPACKING

THOROUGHLY INSPECT EQUIPMENT UPON ARRIVAL.

If goods are received short or in a damaged condition, it is important that you notify the carrier's driver **before he leaves your company** and **insist** on a notation of the loss or damage across the face of the freight bill. Unless this is done, no claim can be enforced against the transportation company.

If concealed loss or damage is discovered, notify the carrier at once and insist on an inspection. This is absolutely necessary! A concealed damage report must be made no later than seven (7) days from the date the shipment was delivered. Unless you do this, the carrier will not consider any claim for loss or damage. The carrier's agent will then make an inspection and grant a concealed damage notation. If you give the transportation company a clear receipt for the goods that have been damaged or lost in transit, you do so at your own risk and expense.

All claims must be filed within 7 Days of delivery date or carrier will not accept them.

Sealer Sales is willing to assist in every possible manner to collect claims for loss or damage; however, this does not hold Sealer Sales responsible for collection on claims or replacement of material.

SPW-983 Pallet Wrapper Manual

Unpacking

* Picture shown with optional ramp



Your model SPW-983 is enclosed in a wooden crate for protection. If your machine does not arrive in good condition, write on shipping paperwork that concealed damage may have occurred. You must write on bill of lading that **“Concealed Damage”** may have occurred. **If you do not – The Freight companies will not pay any damage claims filed due to clear signed bill of lading.**

Remove stretch film protective wrap and remove pallet wrapper from crate.

* Pallet Wrapper is fork lift portable and has fork channel at base of frame. You may use these channels to remove the Pallet Wrapper with fork lift.

Installation & Set Up



Cut nylon straps holding mast down.



Cut nylon straps that hold pre-stretch unit in place.



Remove protective plastic stretch film from tower.

***The tower is very heavy- Do not attempt to lift alone. Using two to three people lift tower upward.**

SPW-983 Pallet Wrapper Manual

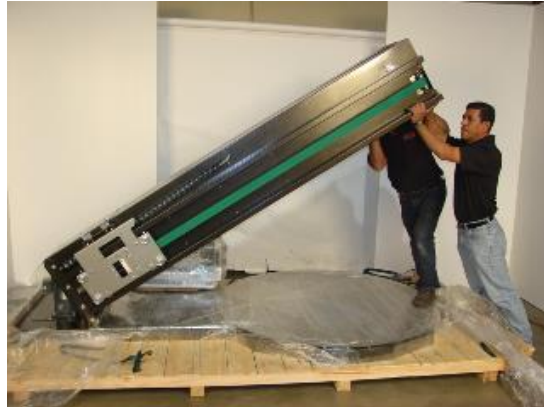

Push tower upward into up right position.



***Very Important**

Take special care you do not pinch cables underneath tower when installing

Bolt and Key bag

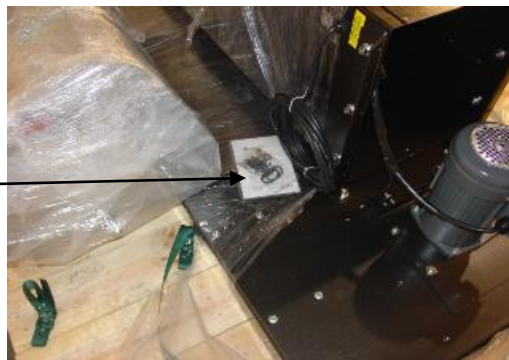

Remove bag with bolts and lock key for control panel.

SPW-983 Pallet Wrapper Manual



Use the 6 bolts provided to mount tower to base using 3 bolts on each side.

Installing Film Carriage



Remove plastic covering from Base and turntable.

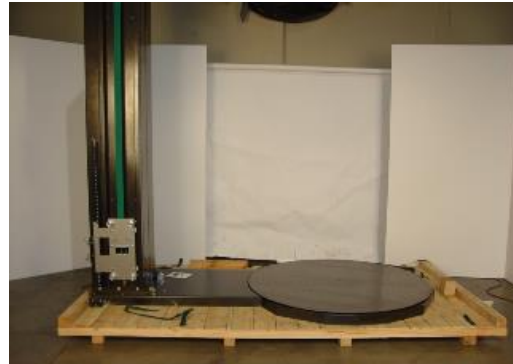

Your machine should look like this.



Remove plastic from pre-stretch Assembly



Remove 4 nuts and washers from pre-stretch mounting plate.



* Note-The pre-stretch unit is extremely heavy. Use two people to lift into position.



SPW-983 Pallet Wrapper Manual

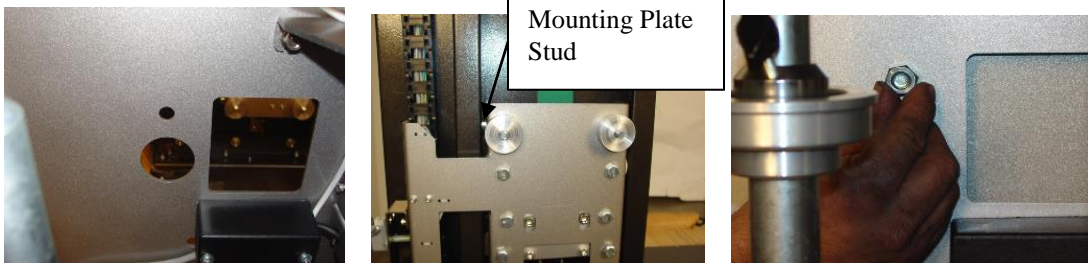

Using the small hole line up with threaded stud on mounting plate.



1. Cut wire tie connecting cables
2. Use quick disconnects to attach cables
3. Lock into position

SPW-983 Pallet Wrapper Manual

Remove Pallet Wrapper from Base



1. Remove the 2 bolts from Holding plate near tower base
On both sides of machine



2. Remove 2 bolts from holding plate at opposite end of machine near turntable



Using forklift from rear of machine place forks in upper half of channel frame.

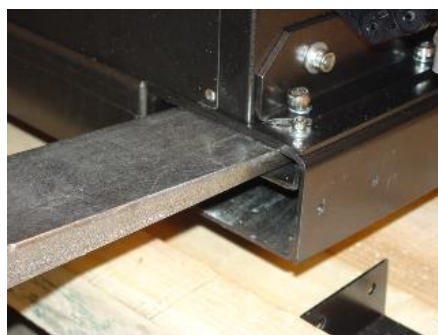

Raise forks to lift frame from base



Insert 2X4 underneath frame to raise up

SPW-983 Pallet Wrapper Manual

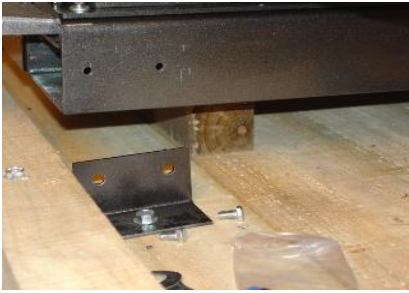

Remove forks from top channel.



Insert forks into lower channel (one with larger opening) push forks into channel as far as possible. Lift machine off pallet and place on floor in desired position.

Installation of optional loading ramp

Use forklift to bring ramp next to turntable base. Lift ramp using slot handles on each side. Metal pin on ramp fits into hole on base frame of pallet wrapper—simply drop into position—ramp can be mounted from all three sides.

Ramp is for use with pallet jacks ONLY, do not attempt to use a forklift and drive up the ramp as it is not designed to carry the weight of a forklift and it may cause the ramp to bend or flex and damage it.

SPW-983 Pallet Wrapper Manual

Plug Machine In

Machine comes complete with power cord and 110volt plug.

***Make sure to use a dedicated line-** Do not run any other equipment on same power line.

Before plugging in machine make sure main power switch is in off position.

Plug into regular 110 volt power outlet.

Make sure the voltage supplied to the machine is **110 volt**.

Installation of film roll



Remove roll lock bearing and place roll of 20" stretch film over shaft



Open front door and lift the 3 adjustable rolls out of the holding slots.
*Lift and pull forward.

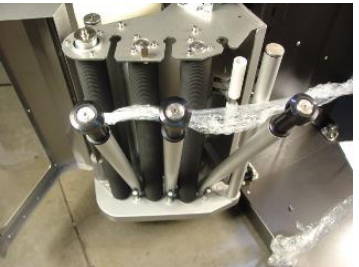

Feed the film through the rollers by simply laying the film in between the rubber rollers and the movable aluminum rollers then simply raise the aluminum rollers back into place and make sure the top handle drops into the slot in the top. Now close the safety cover to activate the pre-stretch unit and feed the film.

SPW-983 Pallet Wrapper Manual

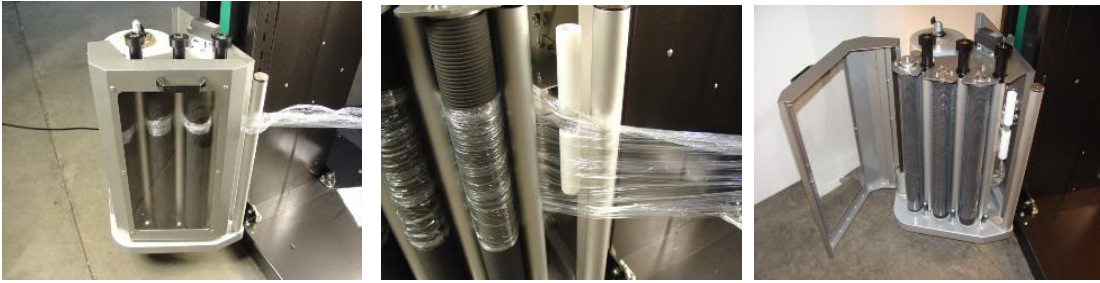

Pull the film toward you. You will activate the white plastic feed roller. The film should look like this when feed correctly.

Film Threading Diagram

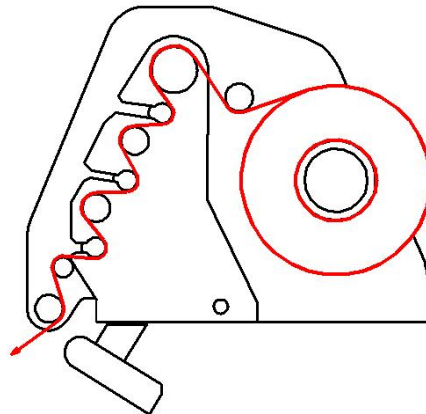

SPW-983 Pallet Wrapper Manual

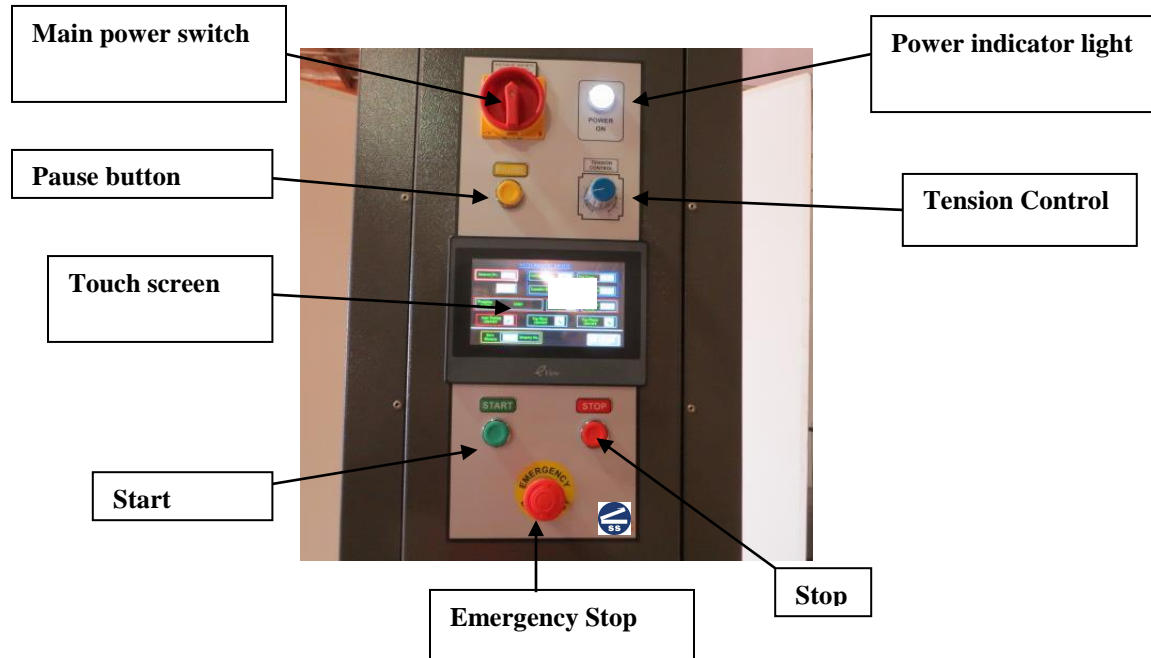

Front Control Panel

Main Power Switch-Turns power to machine ON or OFF

Pause Button- Allows operator to pause the pre-stretch head during the wrap cycle to reinforce a specific area of the pallet load making it more secure

Touch Screen- Main screen from which all functions are preformed

Start Button- Initiates machine cycle start

Emergency Stop Button- Immediately stops all machine functions

Stop Button-Will stop when cycle is complete

Tension Control-Allows operator to either apply the film very lightly to the pallet load when the tension control is set at 2-3 on the dial or you can apply the film very tightly to the pallet load when the tension control is set at 4-6 on the dial. (This setting does not affect the pre-stretch set at 225%)

Power Indicator Light-When lit shows there is power to the machine

SPW-983 Pallet Wrapper Manual

Turning on Machine



Off position



On position

Turn power switch to **ON** position

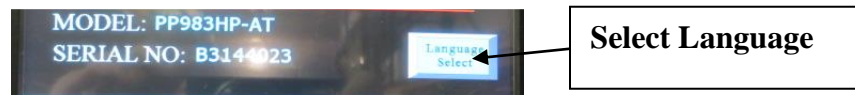

This is the first screen you will see when the machine is turned on.

By pressing the select language icon you will have the option to select from different languages (depending on what was pre-programmed into machine)

SPW-983 Pallet Wrapper Manual

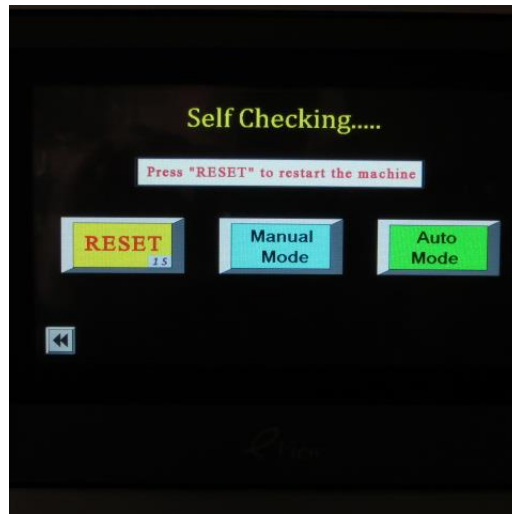

Once the language is selected the machine will self check – If all functions are working it will PASS-Press RESET if failed or press Manual Mode or Automatic Mode to continue.

For the purpose of this example press “**Automatic Mode**” to start. (Or you can wait 5 seconds and it will automatically go to the automatic mode screen)

Touch Pad Control Panel- Automatic Mode

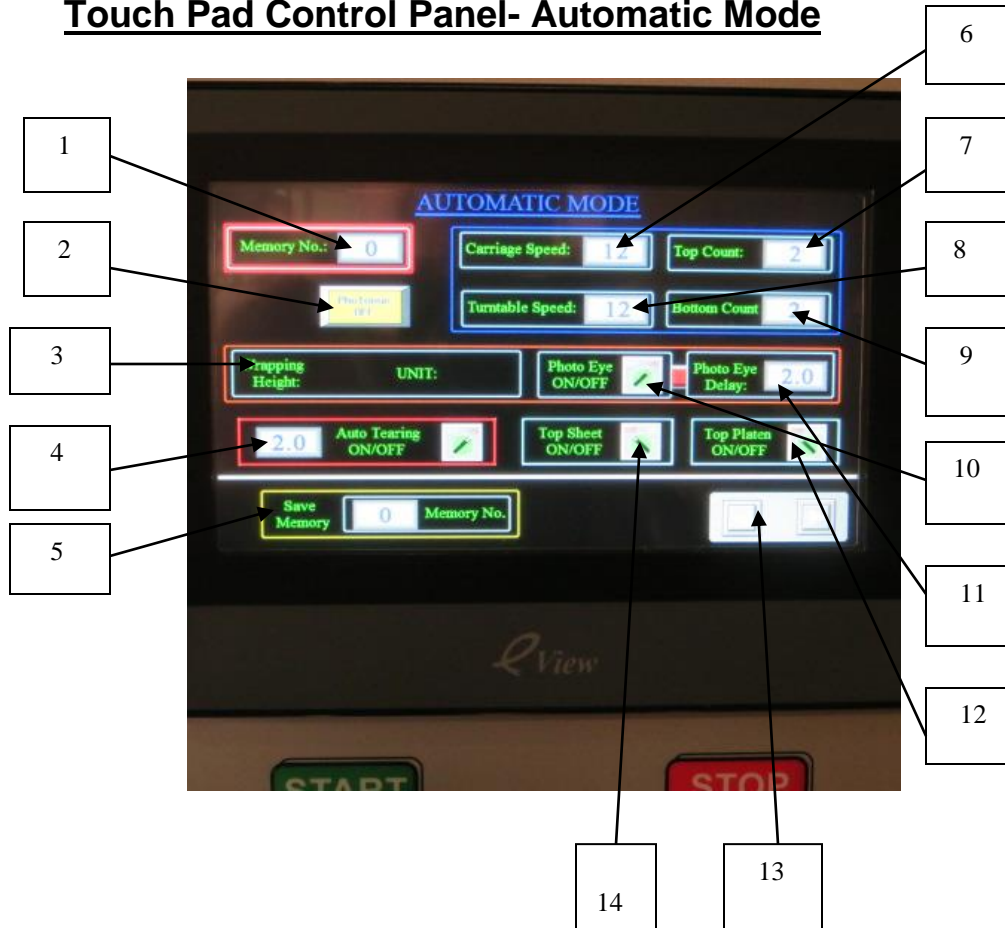

1. **Memory Number**-Select program memory number that was set for a specific wrap cycle.
2. **Photo Eye Off**- “Indicator only” shows if the photo eye is on or off.
3. **Wrapping Height (unit)** – When photo eye is in off mode operator can set wrap height manually (refer to manual mode page)
4. **Auto Tearing (Insta-Cut)**- Optional Feature located on film carriage)- If available on your machine when activated a small devise designed to tear the film at the end of the wrap cycle will cut the film eliminating the need for the operator to manually do this function. (touch icon to turn on or off)
5. **Save Memory**-Allows operator to save settings in a specific program memory location.

SPW-983 Pallet Wrapper Manual

6. **Carriage Speed**- Sets the speed of the film carriage traveling up or down. This speed determines the amount of film overlap that is created on the pallet load.
7. **Top Count**- Is the number of wrap the machine will go around a pallet load at the top of the pallet.
8. **Turntable Speed**- Speed at which the turntable will spin 0-12 RPM
9. **Bottom Count**- Number of time the machine will wrap the bottom of the pallet load.
- 10 **Photo Eye On/Off**- Allows operator to manually turn photo eye on or off by touching icon switch.
- 11 **Photo Eye Delay**- **Increasing the photo eye delay**- allows more film to be overlapped over the top of the pallet load.
Decreasing the photo eye delay-Will reduce the film overlap on the pallet load.
- 12 **Top Platen On/Off**- **(Optional Item)**-If available on your machine this feature is a top platen that will come down and make contact with the top of the pallet load to help secure and stabilize the load when turning at high RPM.
- 13 **Forward and Back Arrows**-For scrolling to different screens forward or backward from Automatic mode screen to Manual mode screen.
- 14 **Top Sheet- On/Off** –Allows the pallet wrap cycle to be stopped near the top of the wrap cycle when turned on allowing the operator time to apply a top sheet to the pallet load (usually polyethylene) to protect the load from the elements, the operator simply hits the start button to complete the cycle..

SPW-983 Pallet Wrapper Manual

Manual Mode Screen

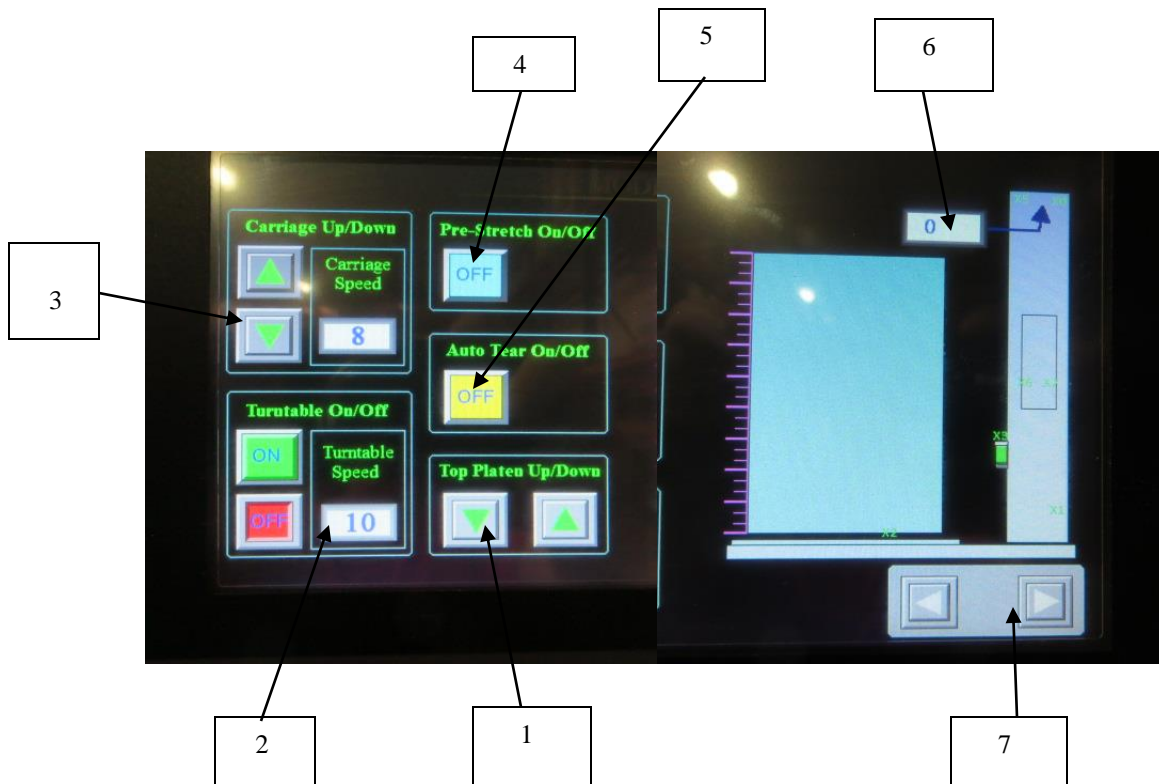

1. **Top Platen Up/Down**-(Optional Item) You can manually move the top platen hold down to stabilize your pallet load.
2. **Turntable On/Off**- You can manually turn on or off the turntable.
Turntable Speed-You can manually adjust the speed at which the turntable will turn.
3. **Carriage Up/Down**- You can manually activate the film carriage to move up or down by pressing the up or down (0-10) arrows.
Carriage Speed- You can manually set the carriage seed at which you prefer the film carriage to move up and down the mast (0-10)
4. **Pre-Stretch On/Off**- Allows operator to disengage the pre-stretch

SPW-983 Pallet Wrapper Manual

-
5. **Auto Tear (Insta-Cut)** (Optional Feature)-When pressed in the **ON** position the ball pin will extend and cut the film.
 6. **Manual Height Setting**-When film carriage is activated and moving upward the height setting or position of the film carriage will be displayed on this screen in a numerical number.
 7. **Forward or Back Arrows**- Allows operator to go from manual mode screen to automatic mode screen.

Sequence of Operation-To Set Up Program**Setting Machine Parameters**

Turn main power switch to “**ON**” position



Machine model and serial # will be displayed (after 5 seconds this screen will disappear and the self checking screen will appear)

SPW-983 Pallet Wrapper Manual

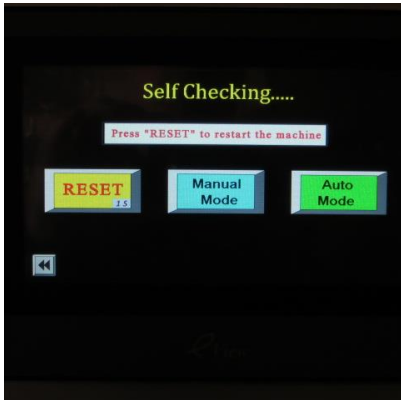

After 5 seconds the self checking screen will automatically advance to the Automatic Mode screen seen below.



The first thing we need to do when setting up a new program is set the **Top** and **Bottom** wrap counts (see below)

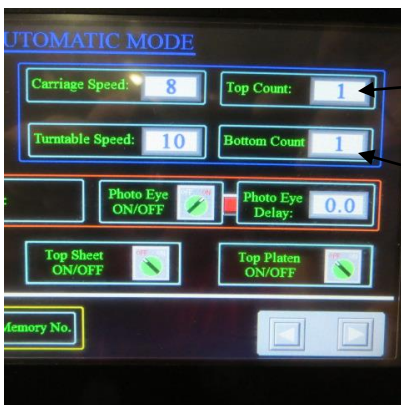

Top Count

Bottom Count

Step 1: Set **Top** and **Bottom** wrap count (1-12)

SPW-983 Pallet Wrapper Manual

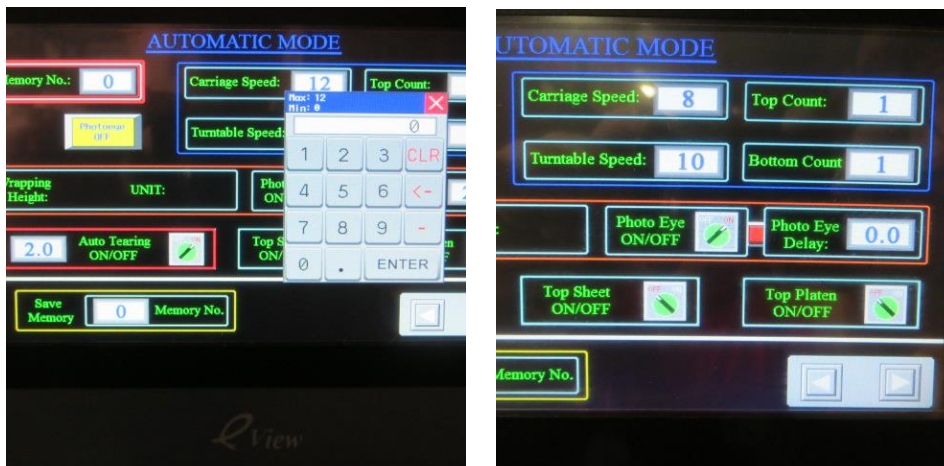

Since we are going to start with program #1 set the top and bottom wrap counts at 1

Top count – This is the number of revolutions the turntable will spin once the film carriage reaches the load height.
 Minimum setting is 0 / Maximum setting is 12

Bottom count – This is the number of revolutions the turntable will spin once the film carriage reaches the bottom position.
 Minimum setting is 0 / Maximum setting is 12

Press the number shown in the box and a numerical keypad will appear. Select the number of Top wraps you want and press the number 1 on the keypad and then press enter to save. Do the same thing for the bottom wrap count, now both are set at 1 wrap on the bottom and 1 wrap on the top.

SPW-983 Pallet Wrapper Manual

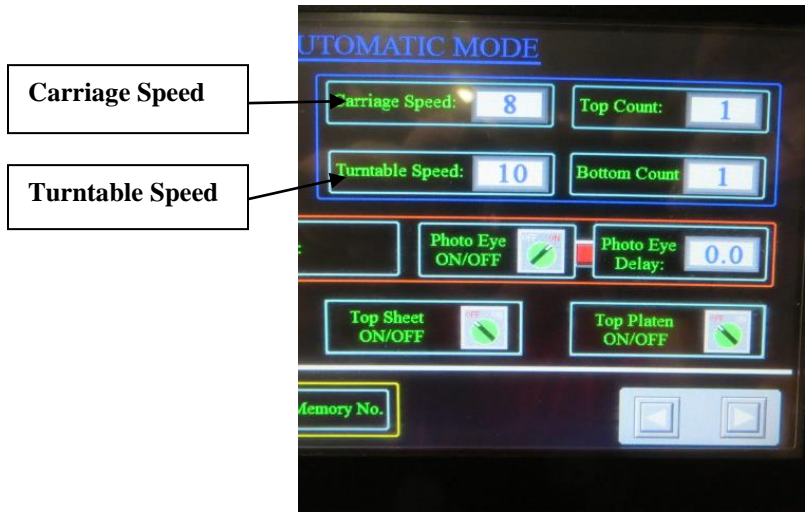

Step 2: Set the Carriage Speed and Turntable Speed

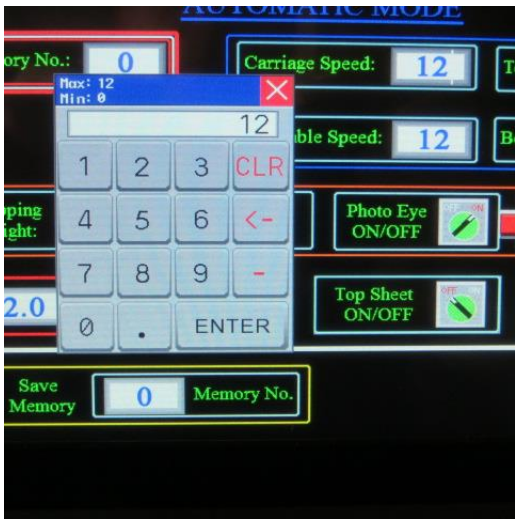

Carriage Speed- This is the speed at which the film carriage moves up and down the mast. For most applications you will want to run the film carriage slower than the turntable speed on order to get a good overlap of the film, if the carriage speed is equal to or higher than the turntable speed you will not get any overlap of film on the pallet load. Minimum setting is 0 / Maximum setting is 12

(recommended factory setting is 8 for most applications)

Note: If you desire to wrap the pallet loads rapidly and are not to concerned with how much film you are apply to the load or how

SPW-983 Pallet Wrapper Manual

secure the load is you can set the turntable speed to 12 and the film carriage speed to 12 and wrap the pallet load as quickly as possible.

Turntable Speed- This is the speed in RPM(revolutions per minute) that the turntable will rotate. This is set the same way and manner as you set the carriage speed.

Minimum setting is 0 / Maximum setting is 12 RPM.

(Recommended factory setting is 10 for most applications)

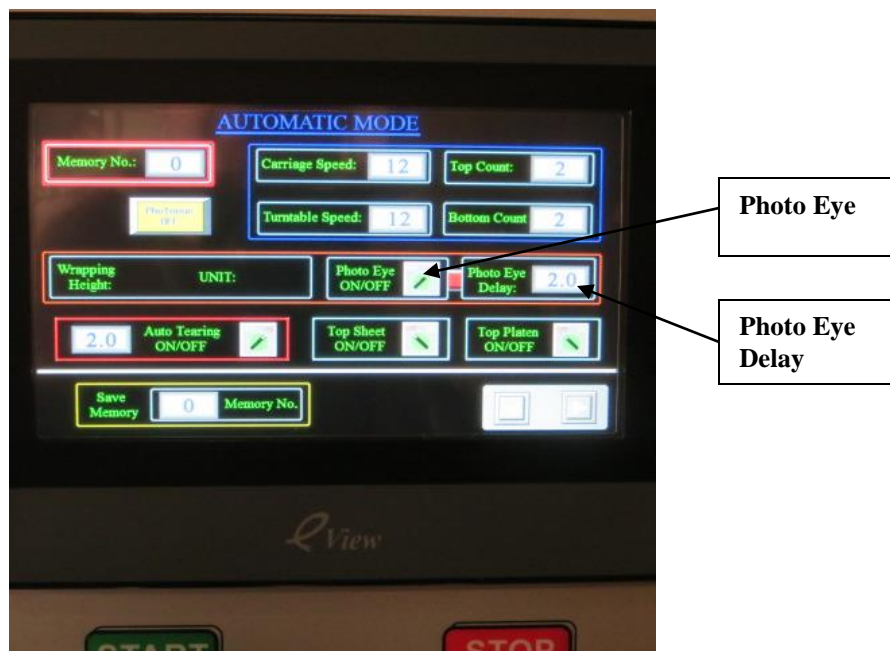

Step 3: Set Photo Eye and Photo Eye Delay or Photo Eye OFF

Photo Eye-Press the icon switch on the screen to the **ON** position. The photo eye will now be active and will seek the height of the pallet load for wrapping.

Photo Eye Delay- The photo eye delay is numerical timed value used to determine how much time the film carriage will continue to rise after the photo eye sees the top of the pallet load. (Example: If the photo eye delay is set on 0.0 the film carriage will not wrap to the top of the pallet load, but if the photo eye delay is set at 2.0 the film

SPW-983 Pallet Wrapper Manual

carriage will most likely wrap 2-3 inches above the pallet load height giving an overlap of film on the top of the pallet load for added wrap security.) The photo eye delay is an adjustment that will need to be tried at differing settings until you reach the desired setting for your specific pallet load.

Factory recommended setting for most pallet loads is 2.0

Photo Eye Off: An example of when you might want to turn the photo eye off and actually set the wrap height would be if you are wrapping a pallet of tires that are black and the photo eye does not want to read or see the black tires, or you are using a black stretch film for a high value pallet load and the customer does not want the contents of the pallet seen, once the turntable spins around once and covers the pallet the photo will get a false reading seeing the black surface of the film and will stop. Follow these simple steps below to turn the photo eye off and use the manual height setting to solve this problem.

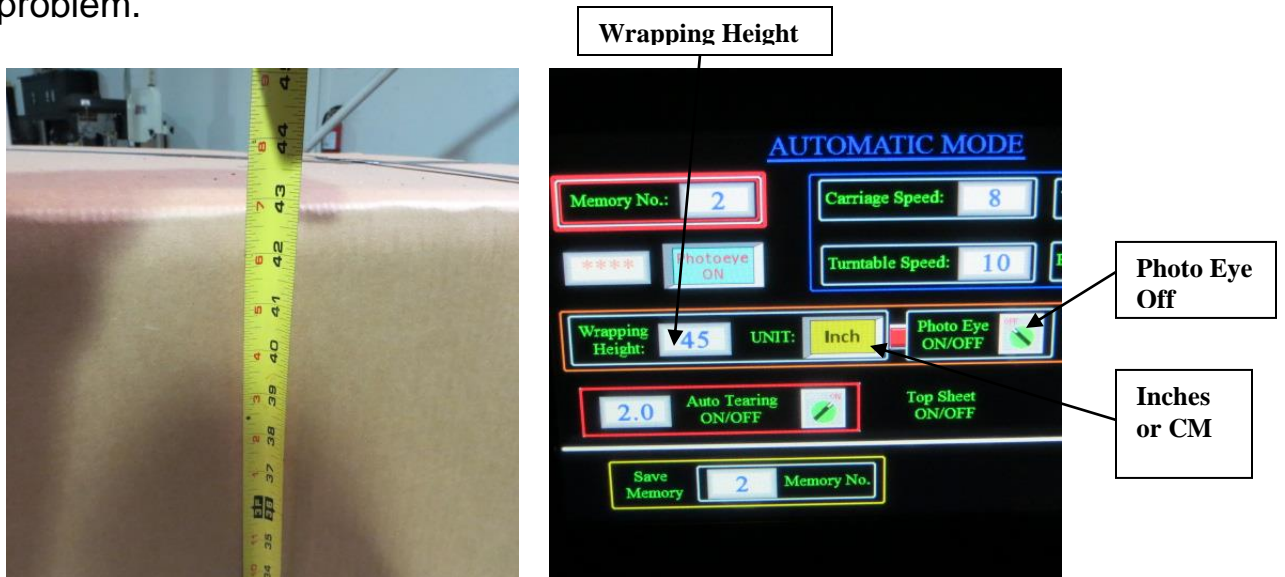

Step One: Determine what the height of the pallet load you want to wrap is, in this case our pallet load is 43” tall from the top of the turntable to the top of the box we want to wrap.

Step Two: Turn the photo eye icon switch **OFF** and insert the pallet height in the box that says “wrapping height” in this case we wanted a

SPW-983 Pallet Wrapper Manual

little overlap on the top of the box so we entered 45". Make sure you have the box check for inches and not "CM" Centimeters.

If this will be a pallet load that you will be doing often you can go ahead and save these setting in any memory location you choose.

Press the "Start" button and the machine will wrap this pallet load as if the photo eye was seeing the pallet load but will go to the height you have set in the wrapping height setting.

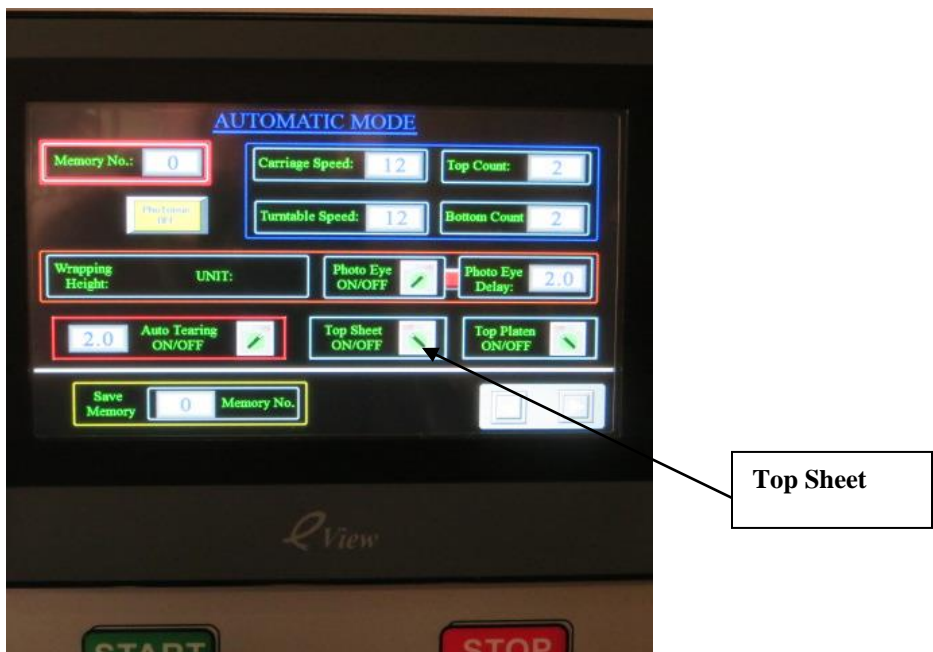

Step 4: Set the Top Sheet On/OFF

By pressing the top sheet icon on the touch screen you can turn ON or OFF the top sheet application. When activated (ON) the pallet wrapper will run through it's normal wrap cycle going to the top of the load and stopping shortly after it starts to head downward and then stop allowing time for the operator to place a top sheet (usually a polyethylene sheet dispensed from a roll) and place this over the top of the pallet load for added protection from the elements, the wrap cycle will resume once the operator hits the Start button again the machine will now complete its wrap cycle.

Step 5: “Optional Item”-Top Platen ON/OFF



Top Platen



SPW-983 with Top Platen

Step 5: Using the touch screen icon to turn the top platen ON or OFF. When **ON** the top platen will move downward until it touches the top of the pallet load with the disc helping to secure the top of the pallet load prior to the turntable spinning thus helping to stabilize an uneven or unstable pallet load. This is also very good if you have a light weight unstable load that you would like to wrap at a high rate of speed with the turntable set at 12 the top platen will secure this pallet load at higher speed wrapping.

Step 6: “Optional Item”- Auto Tearing / Insta-Cut

Insta-Cut / Auto Tearing



The Insta-Cut / Auto Tearing “**Optional**” feature will automatically tear the film at the end of the wrap cycle.

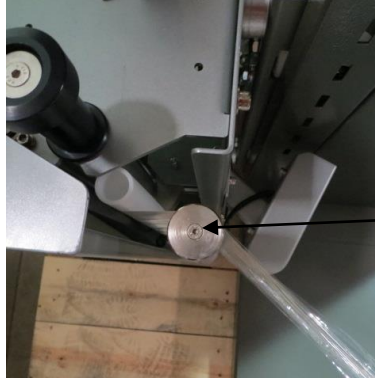

Place film on
inside of Last
Roller

Normal film treading goes in front of the last roller but is the insta-cut does not cut the film properly place the film on the back side of the last roller (shown above) bringing the film closer to the insta-cut unit to ensure a positive cut every time.

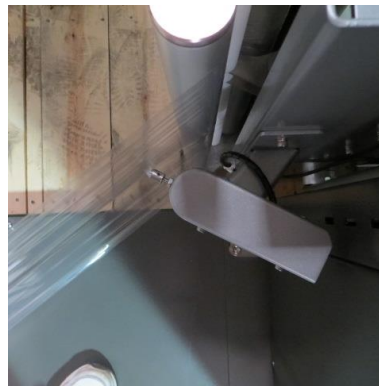

The Insta-Cut unit is mounted using a pivot bolt which will allow you to pivot and angle the insta-cut device at any angle preferred in order to achieve a good cut on the stretch film.

SPW-983 Pallet Wrapper Manual

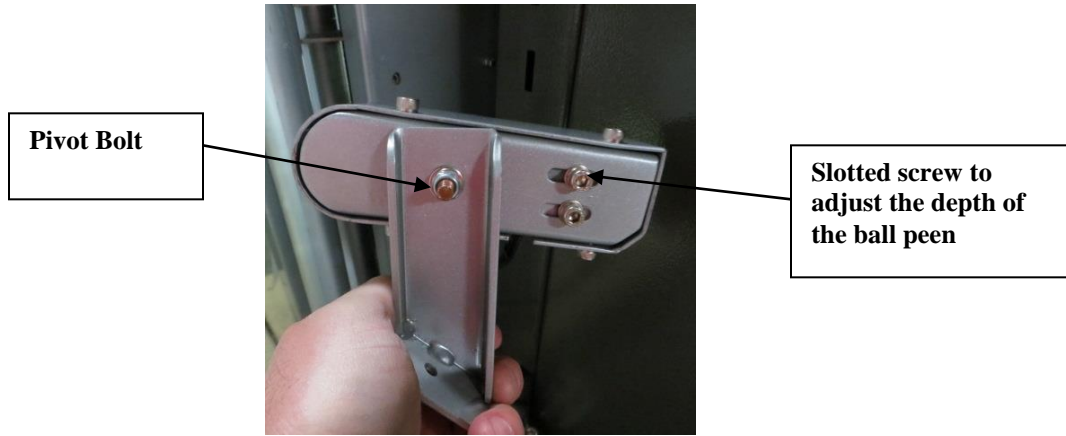

You can see the pivot bolt in the center, and on the right side you can see the 2 slots for adjustment of the insta-cut ball peen by sliding this forward to can increase the stroke of the ball peen pushing the ball peen deeper into the film to insure a good cut.

Step 7: Setting the Tension Control

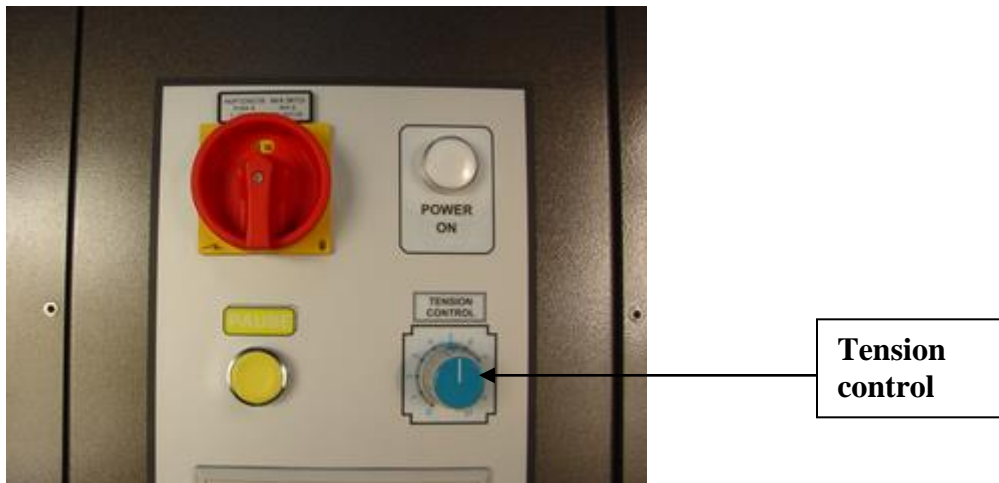

Your model SPW-983 comes with a pre-stretch film delivery system that is factory pre-set at 225%.

SPW-983 Pallet Wrapper Manual

The **Tension Control knob does not change the % of pre-stretch**. This knob controls the amount of **"force to load"** that is applied to the pallet load.

Example: If pre-stretch tension knob is set at 2 on dial the film will be applied very loose onto the pallet. If the dial is set at Maximum 10 on the dial, the film may break or it will possibly crush the corner of corrugated boxes. The amount of pre-stretch always stays the same at 225%

* The normal operating range is from 3 to 6 on the dial

You will need to find a happy medium for your particular application based on your load weight, type of load, strength of corrugated used etc.

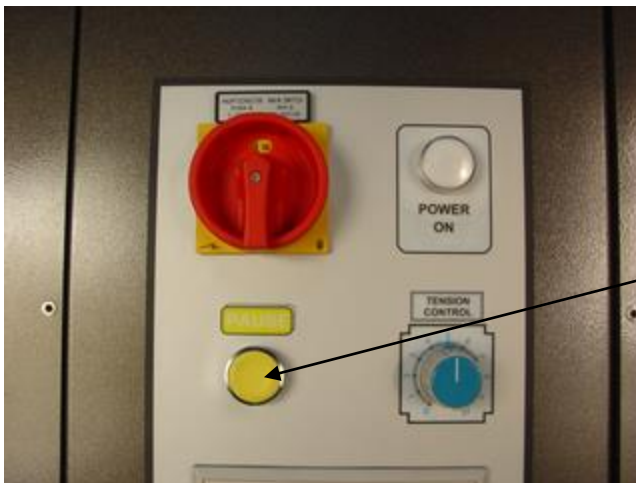
Machine Pause**Pause Key**

– Allows you to pause the film carriage to reinforce a certain area of your pallet. Key must be pressed to work. Once released film carriage will travel again and complete the wrap cycle.



This completes the set up of your first program, if you are satisfied with the settings and machine function then you need to save these settings in program #1



Press the number 1 then press ENTER to save in this memory location

Your first program is now saved in memory location #1

You have 12 memory locations you can set up for different pallet loads.

SPW-983 Pallet Wrapper Manual

We recommend setting program #2 using 2 top wrap counts and 2 bottom wrap counts. Then set up program 3 using 3 top wrap counts and 3 bottom wrap counts. These 3 programs will satisfy 85% of users applications.

Lets say for example you have a pallet load that is very heady and you want to make sure it is secure to the pallet you may want to use 5 wraps on the bottom and 5 wraps on top, we recommend you put this in program 5 as it will be very easy to remember which memory location does what.

Getting Started

Start Switch-ON



Turn power switch to "ON" position



Place pallet load onto turntable and try to center pallet load evenly on turntable base.



Pull several feet of film and attach to turntable base as shown.

SPW-983 Pallet Wrapper Manual

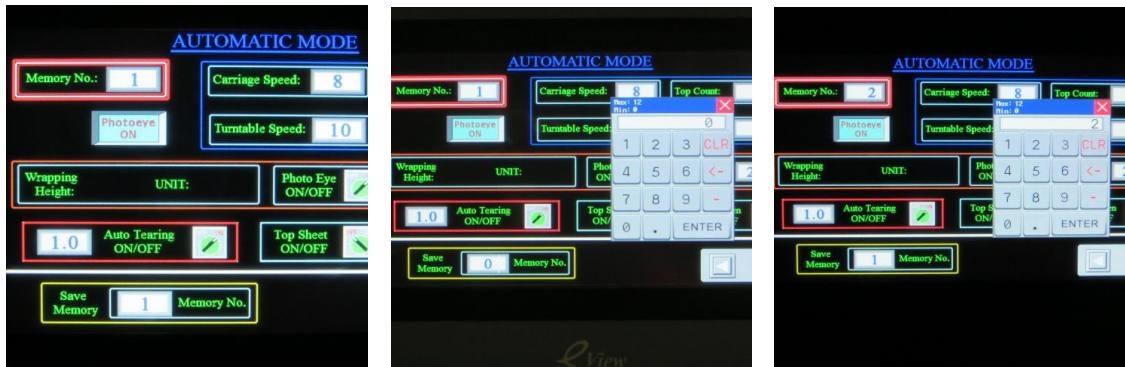

Touch the program memory setting at the top left corner of the touch screen and the key pad will appear, select the program memory that you have previously set up and you would now like to use, for this example we will choose program location 2, we press enter on the keypad and we are now in program #2 which is 2 wraps on the bottom and 2 wrap on the top. (see below)

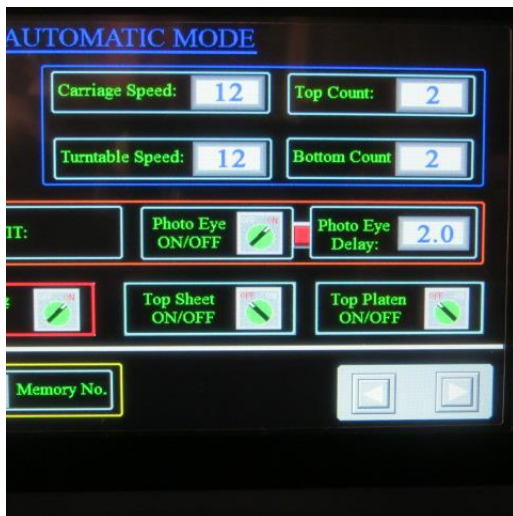

SPW-983 Pallet Wrapper Manual

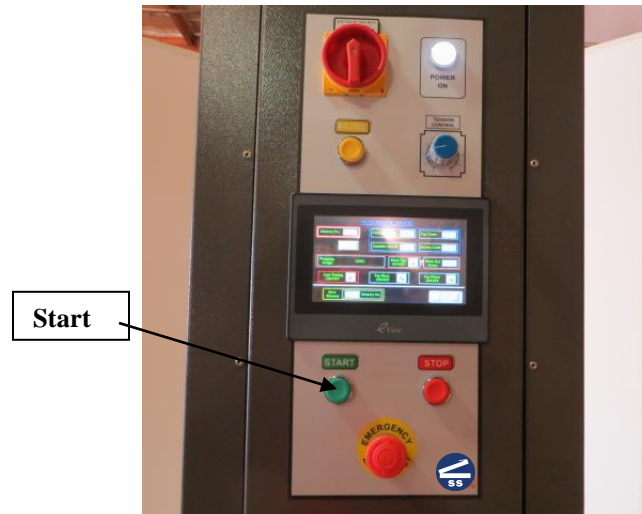

Press the **start** button. The machine will automatically wrap the pallet load. Remember the machine will wrap depending on which program memory you have pre-set it for.

Once the cycle is complete, tear the stretch film and press excess film against pallet load to attach.

Remove pallet load via fork lift or pallet jack (if you have ramp).

Remember you may the cycle at any time by pressing and holding down the button to reinforce a specific area of your pallet load for added strength.

Trouble Shooting-Machine Will Not Start



1. A. Check to make sure machine is plugged into 110 volt service.
- B. Check for voltage present on incoming line.
- C. Check power cord end plug for loose connection.

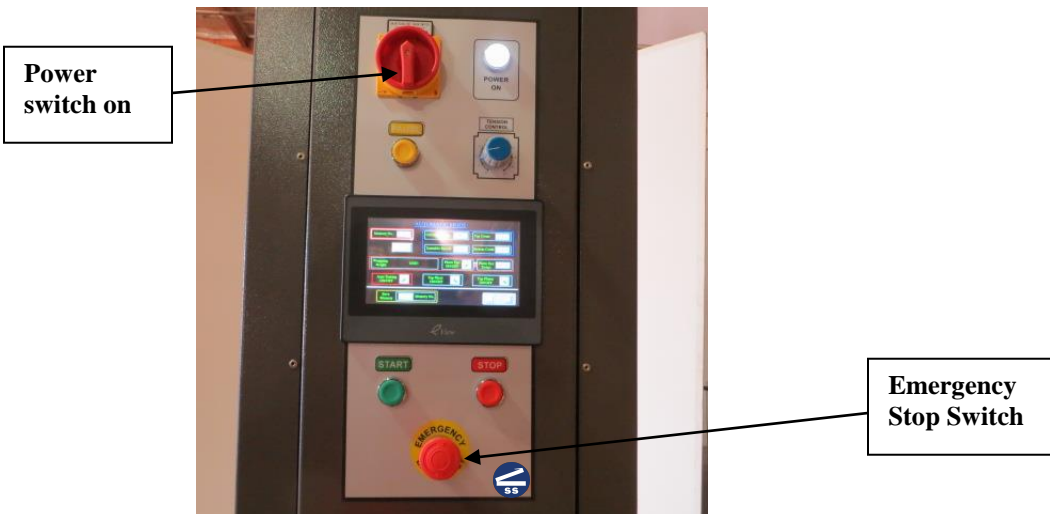

2. Make sure the power switch is turned to **“ON”** position.
3. Make sure the emergency stop switch is not engaged. **Twist turn to disengage.**

SPW-983 Pallet Wrapper Manual



Make sure you have machine in **"auto"** mode-when in **"MANUAL"** mode machine must be operated manually.

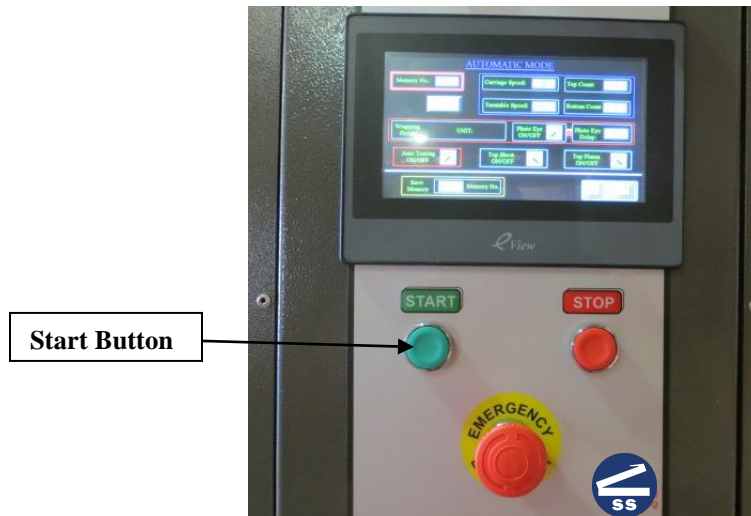

You must press the **Start** button to activate machine cycle.

SPW-983 Pallet Wrapper Manual



Make sure power light is on and display is on.



Use key provided with machine to unlock front control panel to open and check fuses.

SPW-983 Pallet Wrapper Manual

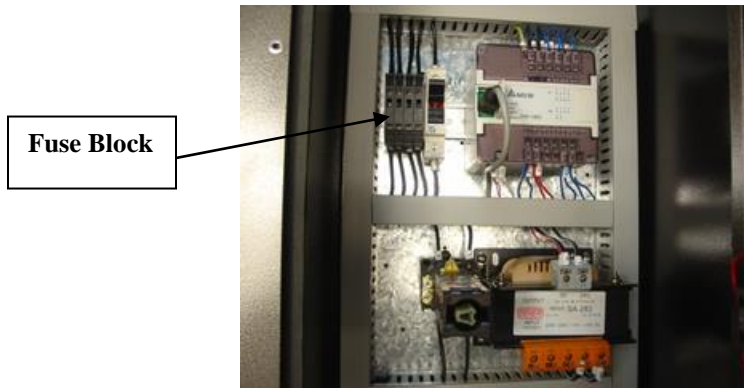

Open fuses in fuse block – check for continuity. Replace if bad.

Machine in Emergency Stop Mode



Turn emergency switch on front control panel "**Counter Clock Wise**" to disengage.

Turntable will not turn

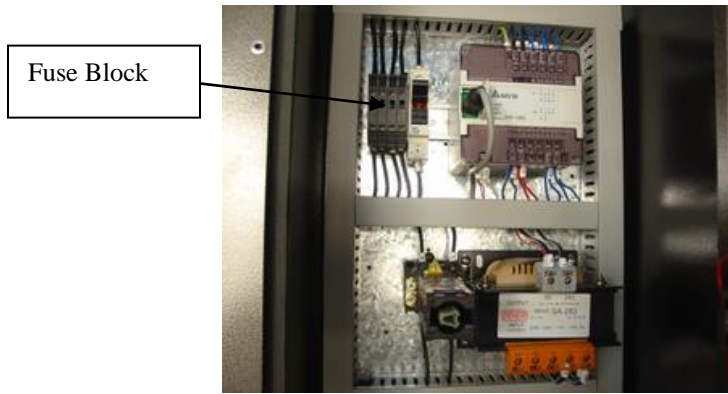

Check fuse- Replace if required.



Remove Back Panel- Check connections to motor. Test motor and please if necessary.

Film Carriage Will Not Rise



Remove the 7 bolts holding turntable top plate and slide off-**lifting not required.**

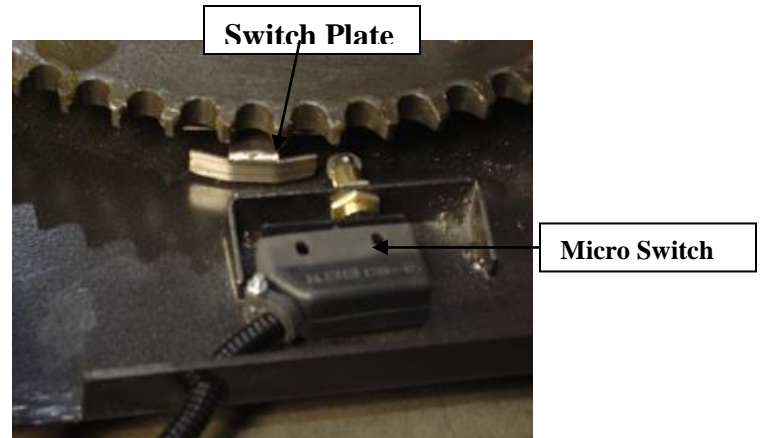

Check micro switch to see if it has come loose- switch must touch plate on sprocket on each revolution. If switch is not hitting plate it will not count revolutions required to start film carriage movement.

Film Carriage Will Not Rise



Remove top cover on tower mast



Check motor-replace if required

SPW-983 Pallet Wrapper Manual

Maintenance

1. No special preventative maintenance operations are required, but it is a good habit to check regularly the condition of the main machine parts, carriage belt, turntable drive chain, etc.
 2. Always replace worn out parts with original spare parts to prevent inefficiency and potential damage to machine.
 3. All maintenance operations should be carried out by personnel in charge of mechanical maintenance.
-
-

Check Drive Chain Tension

Remove the 6 bolts holding cover on base



**Adjustable
Sprocket**

Check chain tension- sprocket's mounted in slotted channel which can be moved to increase chain tension.

SPW-983 Pallet Wrapper Manual



Remove back panel



Motor mounts are slotted and allow greater adjustment of chain tension.

Lubrication of Chain

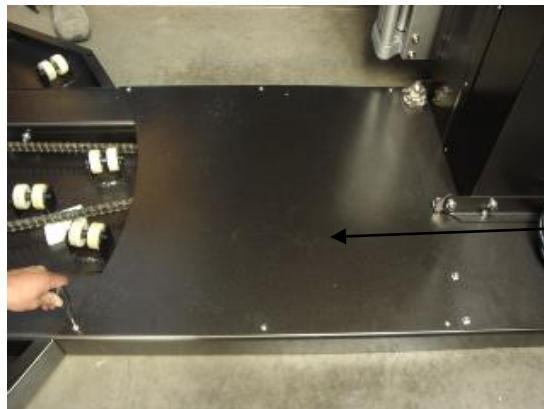

Top Panel

Remove top panel to expose chain

SPW-983 Pallet Wrapper Manual



Use heavy weight chain lube or grease-use liberally.

Replacement of Load Bearing Rollers



Remove 7 bolts holding turntable top plate.

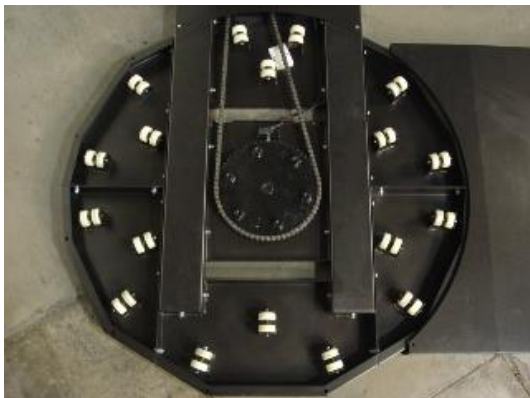

Dual rollers can be easily removed and replaced. Simply lift out and replace with new set.

SPW-983 Pallet Wrapper Manual

Adjustment of Photo Eye

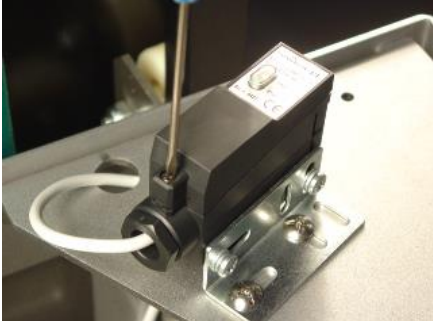

Sensitivity Adjustment

Remove top cover

Time Delay Adjustment



Adjusts time delay allows you to set how much extra film over top of pallet.

Adjustment of photo eye sensitivity.

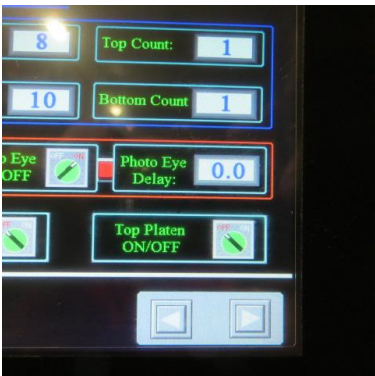

These photo eye adjustments can now be all made increasing or decreasing the time delay from the front control panel.

SPW-983 Pallet Wrapper Manual

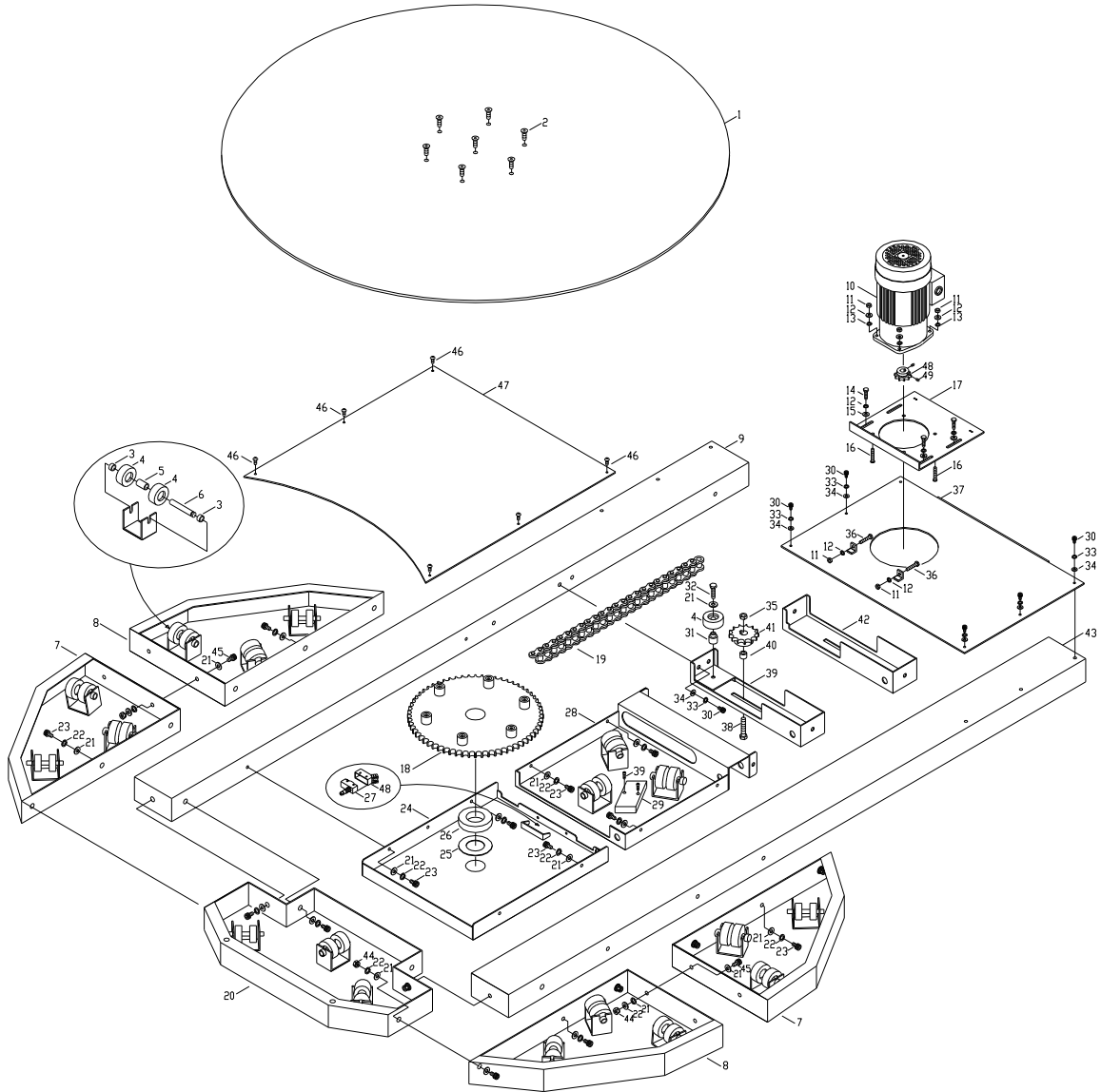

SPW-983 Pallet Wrapper Manual

Pos	Part #	Qty	Description
1	B20001	1	Turntable
2	S04-1025	6	Flat socket head screw, M10x25
3	B10042	36	Collar, short
4	B10043	36	Support roller
5	B10044	18	Collar, long
6	B10041	18	Shaft
7	B20002	2	Turntable base A
8	B20003	2	Turntable base B
9	B20004	1	Support tube LH
10	E63200	1	Turntable motor, 220V/ 50~60Hz, 3Ph.
	E63201		Turntable motor, 240V/ 50Hz, 3Ph.
11	S12-0806	6	Hexagon nut, M8
12	S16-0800	10	Spring washer, M8
13	S15-0801	4	Plain washer, M8 (small)
14	S01-0820	4	Hexagon bolt, M8x20
15	S15-0802	4	Plain washer, M8
16	S04-0825	4	Flat socket head screw, M8x25
17	B20005	1	Motor seat
18	B20006	1	Turntable sprocket
19	B20007	1	Chain
20	B20008	1	Turntable base C
21	S15-1002	33	Plain washer, M10
22	S16-1000	33	Spring washer, M10
23	S02-1016	27	Hex socket bolt, M10x16
24	B20009	1	Turntable base D
25	B10039	1	Washer
26	S50-6211	1	Ball bearing 6211zz
27	E28500	1	Limit switch
28	B20010	1	Turntable base E
29	B20011	1	Plastic board
30	S02-0612	8	Hex socket bolt, M6x12
31	B20012	1	Roller seat
32	S01-1040	1	Hexagon bolt, M10x40
33	S16-0600	8	Spring washer, M6
34	S15-0602	8	Plain washer, M6

SPW-983 Pallet Wrapper Manual

Pos.	Part #	Qty	Description
35	S12-1206	1	Hexagon nut, M12
36	S01-0840	2	Hexagon bolt, M8x40
37	B20013	1	Turntable base F
38	S01-1250	1	Hexagon bolt, M12x50
39	B20014	1	Turntable base G
40	B20015	1	Spacer
41	B20016	1	Tension sprocket
42	B20017	1	Turntable base H
43	B20018	1	Support tube RH
44	S12-1005	6	Hexagon nut, M10
45	S02-1025	6	Hex socket bolt, M10x25
46	S08-0612	6	Truss head machine screw, M6x12
47	B20019	1	Turntable base I
48	E28300	1	Limit switch protection cover
49	B20020	1	Motor sprocket
50	S09-0810	2	Hex socket set screw, M8x10
	B20021	1	Load ramp (Option)

SPW-983 Pallet Wrapper Manual

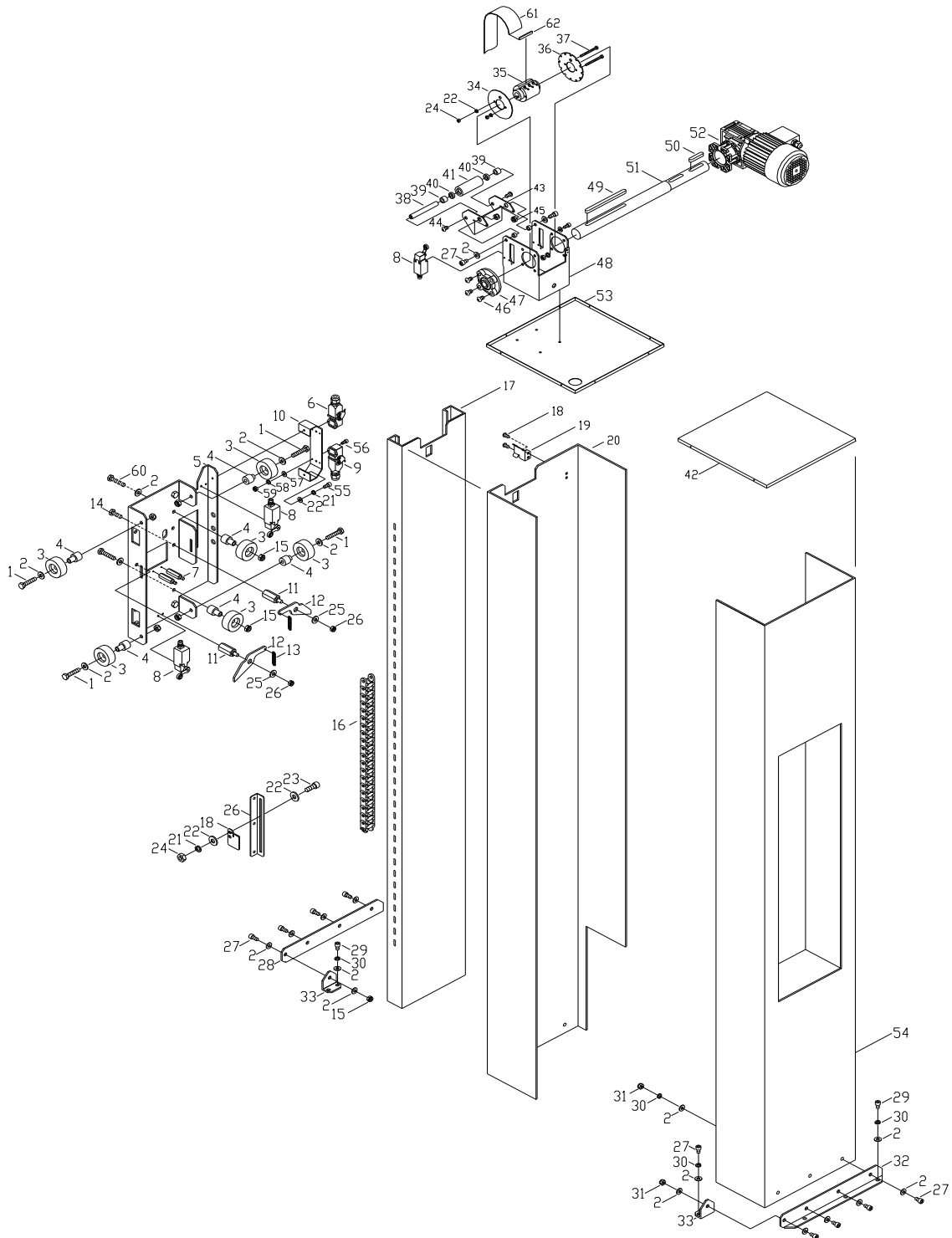

SPW-983 Pallet Wrapper Manual

Pos.	Part #	Qty	Description
1	S01-1050	8	Hexagon bolt, M10x50
2	S15-1002	8	Plain washer, M10
3	B10043	8	Support roller
4	B20012	8	Roller seat
5	B20023	1	Carriage plate
6	E82300	1	4P Quick connector
7	B20024	2	Spring hook
8	E29000	3	Limit switch
9	E82400	1	9P Quick connector
10	B20025	1	Quick connector plate
11	B20026	2	Safety clip seat
12	B20027	2	Safety clip
13	B20028	2	Spring
14	S01-1020	2	Hexagon bolt, M10x20
15	S12-1008	10	Hexagon nut, M10
16	B20029	1	Cable channel
17	B20030	1	Carriage guide plate
18	S08-0510	5	Truss head machine screw, M5x10
19	B20031	1	Upper limit switch trigger plate
20	B20032	1	LH tower
21	S16-0600	2	Spring washer, M6
22	S15-0602	4	Plain washer, M6
23	S02-0616	2	Hex socket bolt, M6x16
24	S12-0605	2	Hexagon nut, M6
25	S15-0802	2	Plain washer, M8
26	S12-0806	2	Hexagon nut, M8
27	S02-1025	8	Hex socket bolt, M10x25
28	B20033	1	LH tower mounting bracket
29	S02-1016	4	Hex socket bolt, M10x16
30	S16-1000	12	Spring washer, M10
31	S12-1006	8	Hexagon nut, M10
32	B20034	1	RH tower mounting bracket
33	B20035	2	Tower hinge angle plate
34	B20036	1	Carriage belt wheel LH plate
35	B20037	1	Carriage belt wheel
36	B20038	1	Carriage belt wheel RH plate
37	S01-0670	2	Hexagon bolt, M6x70

SPW-983 Pallet Wrapper Manual

Pos.	Part #	Qty	Description
38	B20039	1	Shaft
39	B20040	2	Spacer
40	S50-6902	2	Ball bearing 6902zz
41	B20041	1	Active roller
42	B20042	1	Top cover plate
43	B20043	1	Active roller bracket
44	S08-1016	2	Truss head machine screw, M10x16
45	B20044	2	Spacer
46	S08-1030	2	Truss head machine screw, M10x30
47	S50-FC204	1	Ball bearing FC204
48	B20045	1	Motor bracket
49	S21-060690	1	Round end key, 6x6x90
50	S21-060650	1	Round end key, 6x6x50
51	B20046	1	Motor shaft
52	E63300	1	Carriage gear motor, 220V/ 50-60Hz, 3 Ph.
	E63301		Carriage gear motor, 240V/ 50Hz, 3 Ph.
53	B20047	1	Carriage motor group mounting plate
54	B20048	1	RH tower
55	S02-0612	2	Hex socket bolt, M6x12
56	S08-0314	4	Truss head machine screw, M3x14
57	S15-0301	4	Plain washer, M3
58	S16-0300	4	Spring washer, M3
59	S12-0303	4	Hexagon nut, M3
60	S01-1040	4	Hexagon bolt, M10x40
61	B20049	1	Carriage belt
62	B20050	1	Carriage belt stopper

SPW-983 Pallet Wrapper Manual

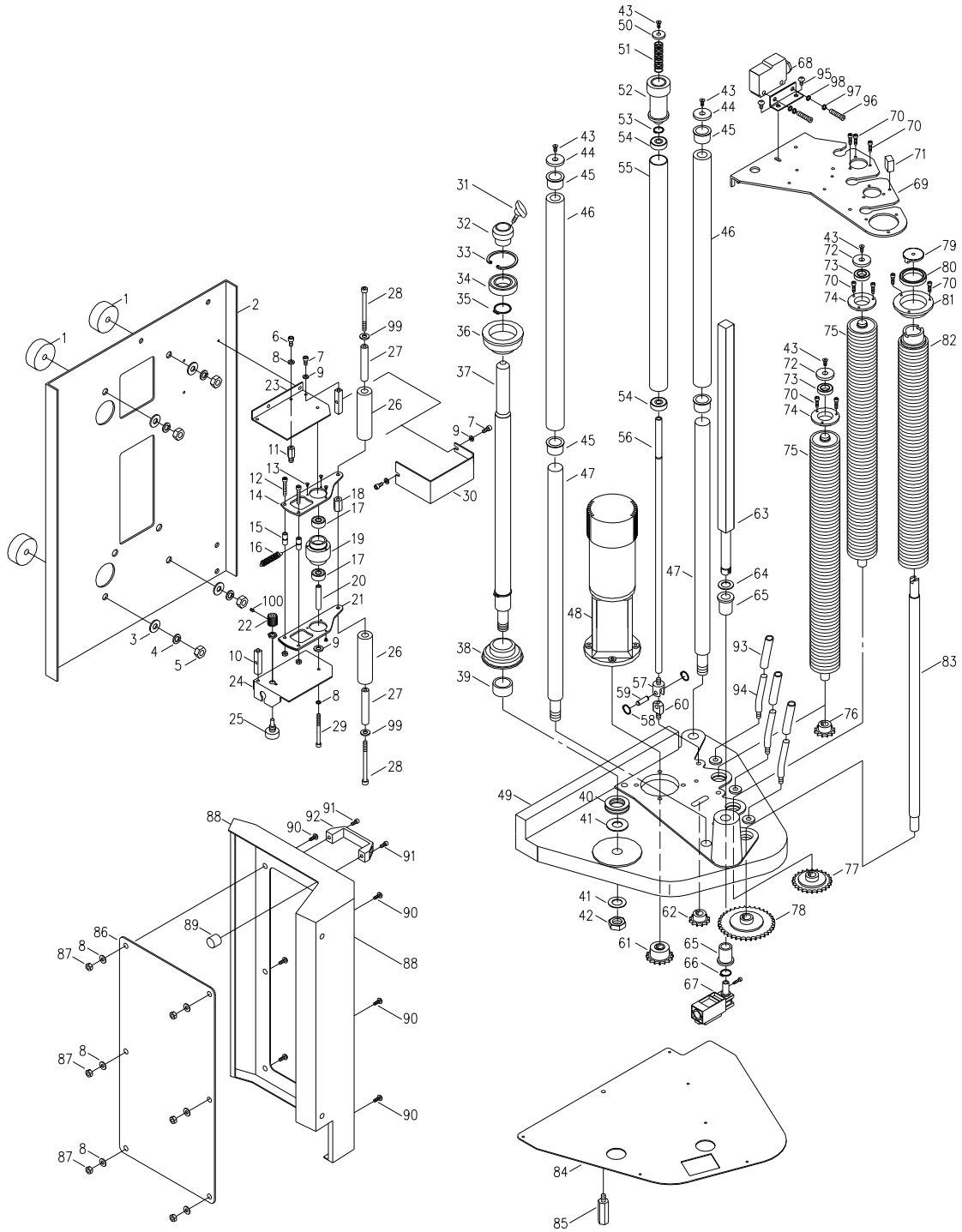

SPW-983 Pallet Wrapper Manual

Pos.	Part #	Qty	Description
1	B20056	4	Washer
2	B20057	1	Side plate
3	S15-1002	4	Plain washer, M10
4	S16-1000	4	Spring washer, M10
5	S12-1006	4	Hexagon nut, M10
6	S02-0612	1	Hex socket bolt, M6x12
7	S02-0512	7	Hex socket bolt, M5x12
8	S15-0601	1	Plain washer, M6
9	S15-0501	7	Plain washer, M5
10	B20058	2	Square pillar
11	B20059	1	Spring hook
12	S02-0530	2	Hex socket bolt, M5x30
13	S04-0308	6	Flat socket head screw, M3x8
14	B20060	1	Trigger plate
15	B20061	2	Trigger plate pillar
16	B20062	1	Spring
17	S50-0608	2	Ball bearing, 608zz
18	B20063	1	Spacer
19	B20064	1	Bearing housing
20	B20065	1	Spacer tube
21	B20066	1	Trigger rack plate
22	B20067	1	Pinion
23	B20068	1	Trigger device upper plate
24	B20069	1	Trigger device lower plate
25	E46100	1	Potentiometer film carriage B103
26	B20070	2	Trigger roller
27	B20071	2	Trigger roller shaft
28	S02-0680	2	Hex socket bolt, M6x80
29	S02-0560	1	Hex socket bolt, M5x60
30	B20072	1	Trigger device side cover
31	B20073	1	Lock knob
32	B20074	1	Lock ring
33	S23-5500	1	Internal circlip, S55
34	S50-6006	1	Ball bearing, 6006zz
35	S24-2500	1	External circlip, R25

SPW-983 Pallet Wrapper Manual

Pos.	Part #	Qty	Description
36	B20075	1	Upper film holder
37	B20076	1	Film shaft
38	B20077	1	Bottom film holder
39	B20078	1	Copper bush
40	S50-1106	1	Surface bearing, 1106
41	S15-2002	2	Plain washer, M20
42	S12-2010	1	Hexagon nut, M20
43	S04-0616	5	Flat socket head screw, M6x16
44	B20079	2	Washer
45	B20080	4	Plastic bearing
46	B20081	2	Roller
47	B20082	2	Roller shaft
48	E63400	1	AC gear motor
49	B20083	1	Casting base
50	B20084	3	Washer
51	B20085	3	Spring
52	B20086	3	Handle
53	S24-1200	3	External circlip, R12
54	S50-6201	6	Ball bearing, 6201zz
55	B20087	3	Roller
56	B20088	3	Roller shaft
57	B20089	3	Upper jointer
58	S24-0800	6	External circlip, R8
59	B20090	3	shaft
60	B20091	3	Bottom jointer
61	B20092	1	Motor sprocket
62	B20093	1	Tension sprocket
63	B20094	1	Door shaft
64	S15-1802	1	Plain washer, M18
65	B20095	1	Copper bush
66	S24-1800	3	External circlip, R18
67	E86100	1	Door safety switch
68	E84100	1	Photo-cell
69	B20096	1	Upper roller mounting plate
70	S02-0510	9	Hex socket bolt, M5x10
71	B20097	1	Magnet
72	B20098	2	Washer

SPW-983 Pallet Wrapper Manual

Pos.	Part #	Qty	Description
73	S50-6903	1	Ball bearing, 6903zz
74	B20099	2	Bearing housing
75	B20100	2	Rubber roller
76	B20101	1	3rd Rubber roller sprocket
77	B20102	1	2nd Rubber roller sprocket
78	B20103	1	1st Rubber roller sprocket
79	B20104	1	Washer
80	S50-6808	2	Ball bearing, 6808zz
81	B20105	1	Bearing housing
82	B20106	1	1st Rubber roller
83	B20107	1	1st Rubber roller shaft
84	B20108	1	Bottom plate
85	B20109	1	Hexagon rod
86	B20110	1	Plastic sheet
87	S12-0605	6	Hexagon nut, M6
88	B20111	1	Safety door
89	B20112	1	Magnet
90	S08-0608	6	Truss head machine screw, M6x8
91	S02-0612	2	Hex socket bolt, M6x12
92	B20113	1	Handle
93	B20114	3	Rubber buffer
94	B20115	3	Stopper rod
95	S08-0612	2	Truss head machine screw, M6x12
96	S08-0630	2	Truss head machine screw, M6x30
97	S16-0600	2	Spring washer, M6
98	S15-0601	2	Plain washer, M6
99	S15-0602	2	Plain washer, M6
100	S09-0405	1	Hex socket set screw, M4x5

SPW-983 Pallet Wrapper Manual

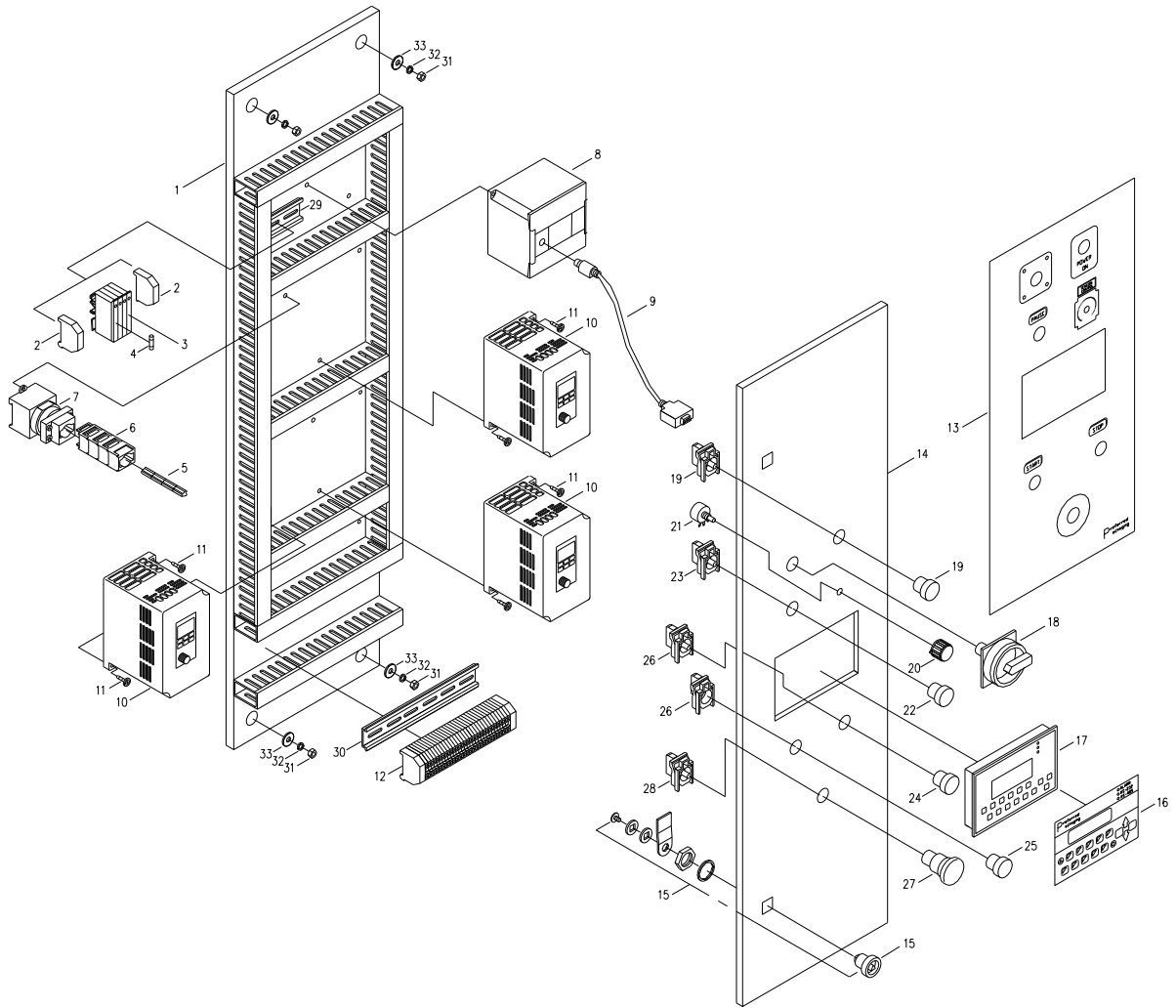

SPW-983 Pallet Wrapper Manual

Pos.	Part #	Qty	Description
1	B20121	1	Control panel base
2	E30900	2	Terminal stopper
3	E32600	4	Fuse box
4	E36612	3	Fuse, 15A
	E36608	1	Fuse, 3A
	E36602	1	Fuse, 2A
5	E24503	1	Power switch – extension shaft
6	E24502	1	Power switch – extension block
7	E24500	1	Power switch – switch unit
8	E90200	1	PLC DVP-16ES
9	E90202	1	DVP-16ES RS-232 cable
10	E67300	3	Inverter Delta S1
11	S10-0508	10	Pan head tapping screw, M5x8
12	E30800	30	Terminal block
13	B20126	1	Control panel sticker – PP983PA
14	B20122	1	Control panel front door
15	E88100	2	Door lock
16	E90001	1	PLC console sticker
17	E90002	1	PLC console TP-02
18	E24501	1	Power switch – knob unit
19	E26500	1	Pilot lamp
20	E47300	1	Knob
21	E45300	1	Potentiometer tension control B302
22	E23200	1	Pause switch – knob button
23	E23201	1	Pause switch – switch unit
24	E23202	1	Stop switch – knob button
25	E23203	1	Start switch – knob button
26	E23204	2	Stop/ Start switch – switch unit
27	E23205	1	Emergency switch – knob button
28	E23206	1	Emergency stop switch – switch unit
29	B20123	1	Mounting plate - short
30	B20124	1	Mounting plate - long
31	S12-0605	4	Hexagon nut, M6
32	S16-0600	4	Spring washer, M6
33	S15-0602	4	Plain washer, M6

SPW-983 Pallet Wrapper Manual

Spare Parts List

Item #	Part #	Description	Qty.	Price
1	E29000	Limit switch	1	
2		Chain lube	1	
3	E28500	Micro switch turntable	1	
4	B10043	Turntable support rollers	2	
5	E39300	Fuse 15A	6	
6	E39100	Fuse 3A	2	
7		Fuse 2 A	2	
Total Cost				\$ Call

SPW-983 Pallet Wrapper Manual

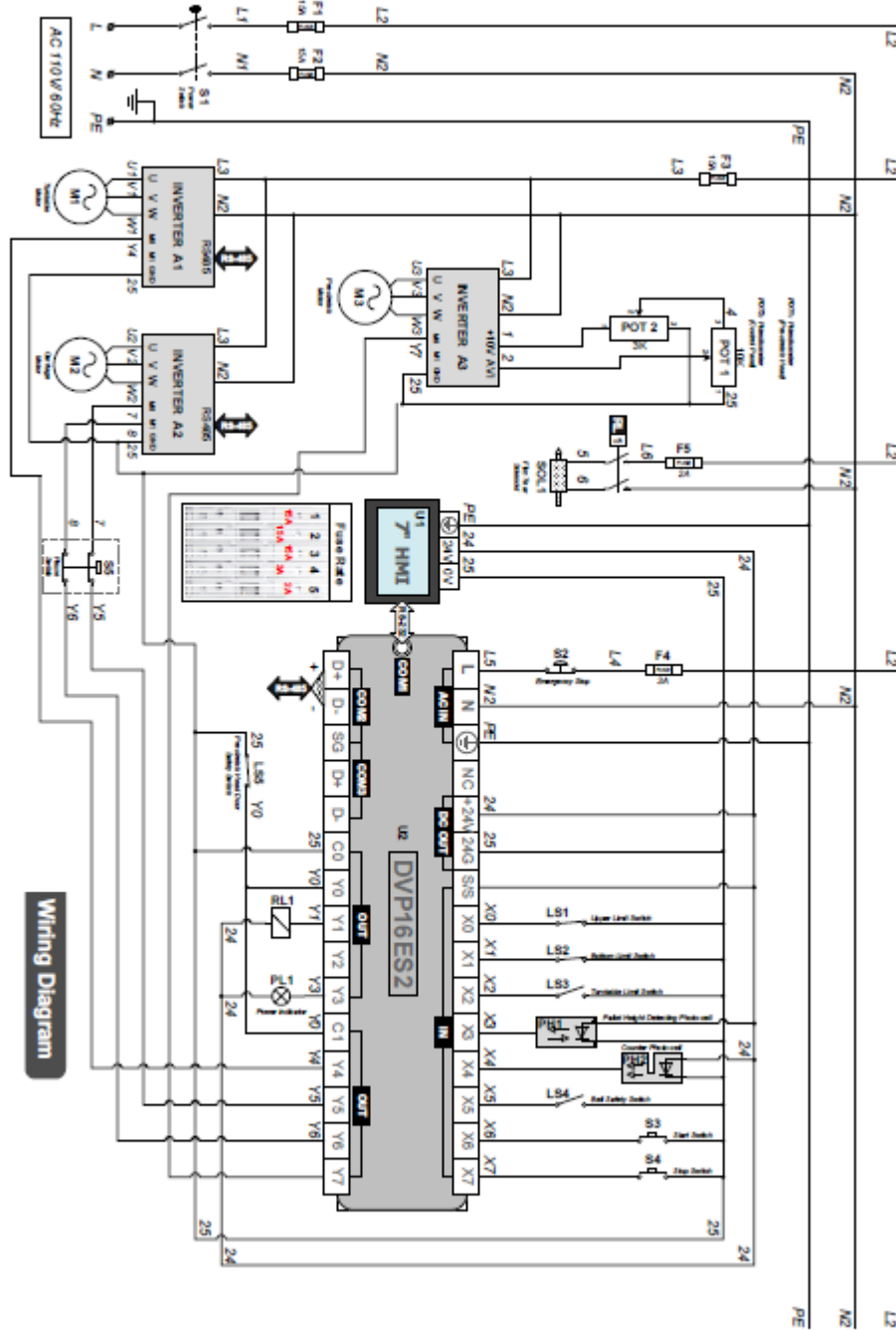

Wiring Diagram

Notes